

 **Kontrol-C**
کنترول سی

STAMFORD[®]

HCI634G - Technical Data Sheet

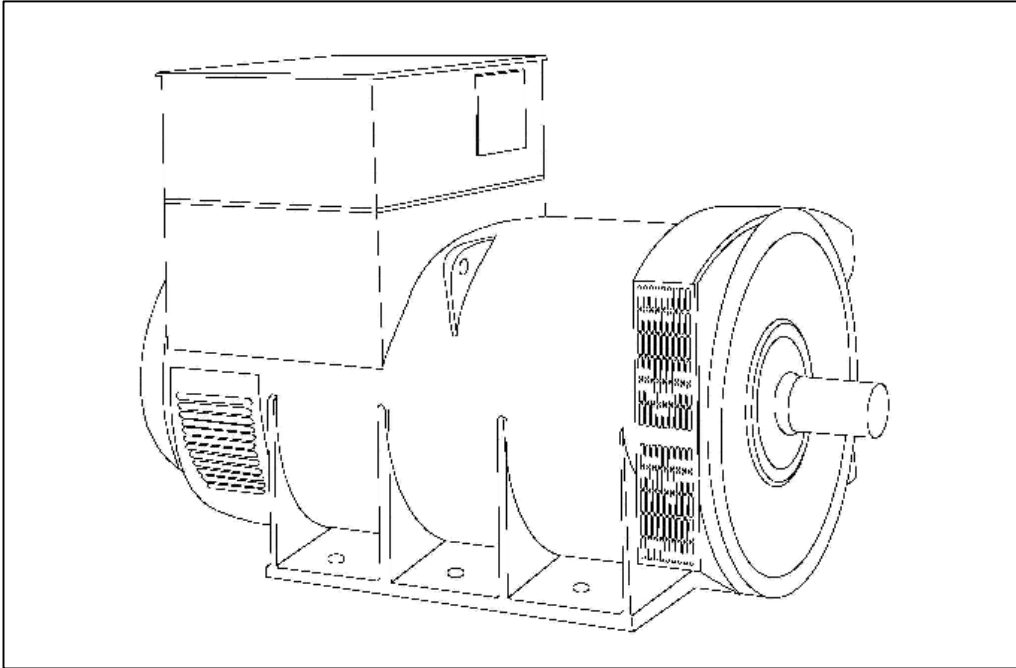

HCI634G

SPECIFICATIONS & OPTIONS



STANDARDS

Newage Stamford industrial generators meet the requirements of BS EN 60034 and the relevant section of other international standards such as BS5000, VDE 0530, NEMA MG1-32, IEC34, CSA C22.2-100, AS1359.

Other standards and certifications can be considered on request.

VOLTAGE REGULATORS

MX321 AVR - STANDARD

This sophisticated Automatic Voltage Regulator (AVR) is incorporated into the Stamford Permanent Magnet Generator (PMG) system and is fitted as standard to generators of this type.

The PMG provides power via the AVR to the main exciter, giving a source of constant excitation power independent of generator output. The main exciter output is then fed to the main rotor, through a full wave bridge, protected by a surge suppressor. The AVR has in-built protection against sustained over-excitation, caused by internal or external faults. This de-excites the machine after a minimum of 5 seconds.

Over voltage protection is built-in and short circuit current level adjustments is an optional facility.

WINDINGS & ELECTRICAL PERFORMANCE

All generator stators are wound to 2/3 pitch. This eliminates triplen (3rd, 9th, 15th ...) harmonics on the voltage waveform and is found to be the optimum design for trouble-free supply of non-linear loads. The 2/3 pitch design avoids excessive neutral currents sometimes seen with higher winding pitches, when in parallel with the mains. A fully connected damper winding reduces oscillations during paralleling. This winding, with the 2/3 pitch and carefully selected pole and tooth designs, ensures very low waveform distortion.

TERMINALS & TERMINAL BOX

Standard generators feature a main stator with 6 ends brought out to the terminals, which are mounted on the frame at the non-drive end of the generator. A sheet steel terminal box contains the AVR and provides ample space for the customers' wiring and gland arrangements. It has removable panels for easy access.

SHAFT & KEYS

All generator rotors are dynamically balanced to better than BS6861:Part 1 Grade 2.5 for minimum vibration in operation. Two bearing generators are balanced with a half key.

INSULATION/IMPREGNATION

The insulation system is class 'H'.

All wound components are impregnated with materials and processes designed specifically to provide the high build required for static windings and the high mechanical strength required for rotating components.

QUALITY ASSURANCE

Generators are manufactured using production procedures having a quality assurance level to BS EN ISO 9001.

The stated voltage regulation may not be maintained in the presence of certain radio transmitted signals. Any change in performance will fall within the limits of Criteria 'B' of EN 61000-6-2:2001. At no time will the steady-state voltage regulation exceed 2%.

NB Continuous development of our products entitles us to change specification details without notice, therefore they must not be regarded as binding.

Front cover drawing typical of product range.

HCI634G
WINDING 312

CONTROL SYSTEM	SEPARATELY EXCITED BY P.M.G.		
A.V.R.	MX321		
VOLTAGE REGULATION	± 0.5 %	With 4% ENGINE GOVERNING	
SUSTAINED SHORT CIRCUIT	REFER TO SHORT CIRCUIT DECREMENT CURVES (page 7)		

INSULATION SYSTEM	CLASS H
PROTECTION	IP23
RATED POWER FACTOR	0.8
STATOR WINDING	DOUBLE LAYER LAP
WINDING PITCH	TWO THIRDS
WINDING LEADS	6
STATOR WDG. RESISTANCE	0.003 Ohms PER PHASE AT 22°C STAR CONNECTED
ROTOR WDG. RESISTANCE	1.75 Ohms at 22°C
EXCITER STATOR RESISTANCE	17 Ohms at 22°C
EXCITER ROTOR RESISTANCE	0.079 Ohms PER PHASE AT 22°C
R.F.I. SUPPRESSION	BS EN 61000-6-2 & BS EN 61000-6-4, VDE 0875G, VDE 0875N. refer to factory for others
WAVEFORM DISTORTION	NO LOAD < 1.5% NON-DISTORTING BALANCED LINEAR LOAD < 5.0%
MAXIMUM OVERSPEED	2250 Rev/Min
BEARING DRIVE END	BALL. 6224 (ISO)
BEARING NON-DRIVE END	BALL. 6317 (ISO)

	1 BEARING	2 BEARING
WEIGHT COMP. GENERATOR	1965 kg	1989 kg
WEIGHT WOUND STATOR	934 kg	934 kg
WEIGHT WOUND ROTOR	814 kg	766 kg
WR ² INERTIA	18.3482 kgm ²	17.8009 kgm ²
SHIPPING WEIGHTS in a crate	2023kg	2029kg
PACKING CRATE SIZE	183 x 92 x 140(cm)	183 x 92 x 140(cm)

	50 Hz				60 Hz			
TELEPHONE INTERFERENCE	THF<2%				TIF<50			
COOLING AIR	1.614 m ³ /sec 3420 cfm				1.961 m ³ /sec 4156 cfm			
VOLTAGE STAR	380/220	400/231	415/240	440/254	416/240	440/254	460/266	480/277
VOLTAGE DELTA	220	230	240	254	240	254	266	277
kVA BASE RATING FOR REACTANCE VALUES	800	800	800	800	875	925	963	1000
X _d DIR. AXIS SYNCHRONOUS	3.14	2.83	2.63	2.34	3.53	3.34	3.18	3.03
X' _d DIR. AXIS TRANSIENT	0.25	0.23	0.21	0.19	0.28	0.26	0.25	0.24
X'' _d DIR. AXIS SUBTRANSIENT	0.18	0.16	0.15	0.13	0.21	0.20	0.19	0.18
X _q QUAD. AXIS REACTANCE	1.88	1.70	1.58	1.40	2.10	1.98	1.89	1.80
X'' _q QUAD. AXIS SUBTRANSIENT	0.21	0.19	0.18	0.16	0.24	0.23	0.22	0.21
X _L LEAKAGE REACTANCE	0.10	0.09	0.08	0.07	0.12	0.11	0.10	0.10
X ₂ NEGATIVE SEQUENCE	0.22	0.20	0.19	0.17	0.24	0.23	0.22	0.21
X ₀ ZERO SEQUENCE	0.03	0.03	0.03	0.02	0.03	0.03	0.03	0.03

REACTANCES ARE SATURATED

VALUES ARE PER UNIT AT RATING AND VOLTAGE INDICATED

T' _d TRANSIENT TIME CONST.	0.185
T'' _d SUB-TRANSTIME CONST.	0.025
T' _{do} O.C. FIELD TIME CONST.	2.35
T _a ARMATURE TIME CONST.	0.04
SHORT CIRCUIT RATIO	1/X _d

**50
Hz**

HCI634G
Winding 312



THREE PHASE EFFICIENCY CURVES

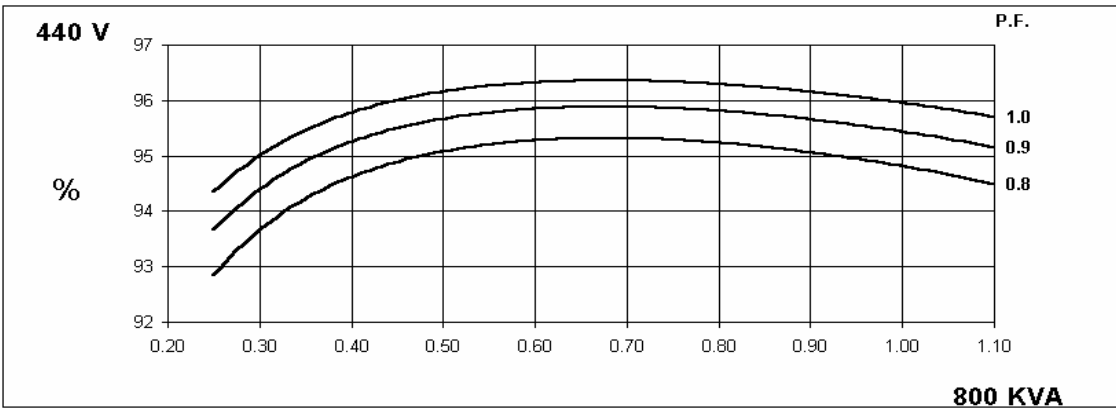
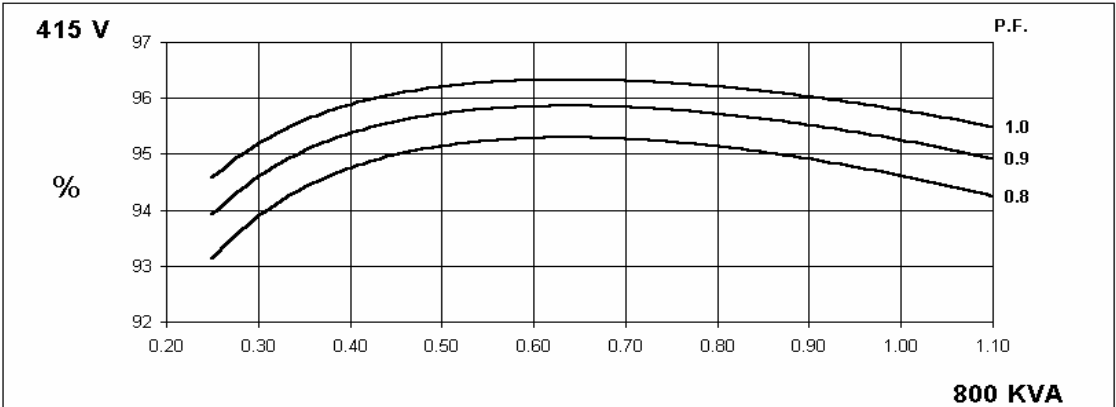
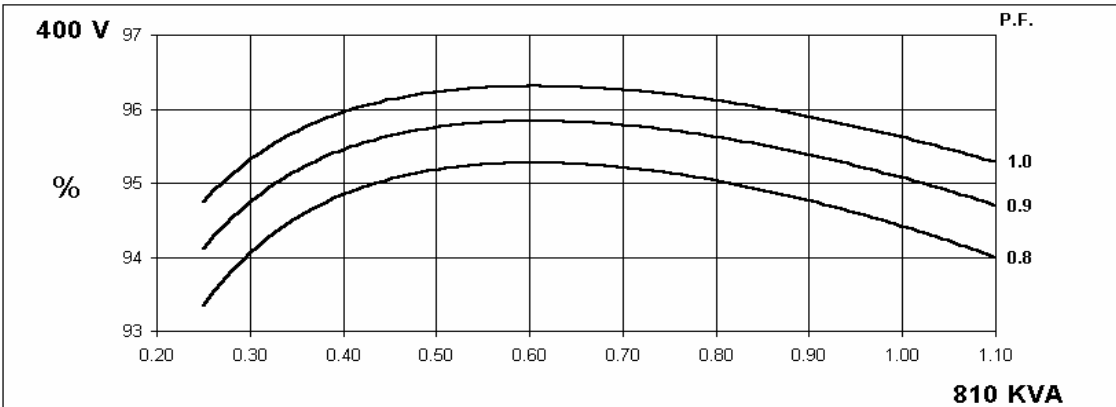
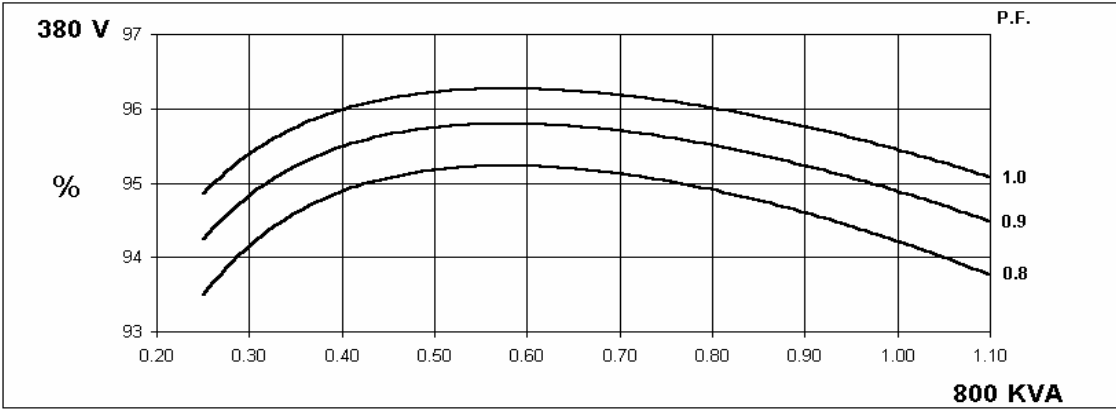

THREE PHASE EFFICIENCY CURVES

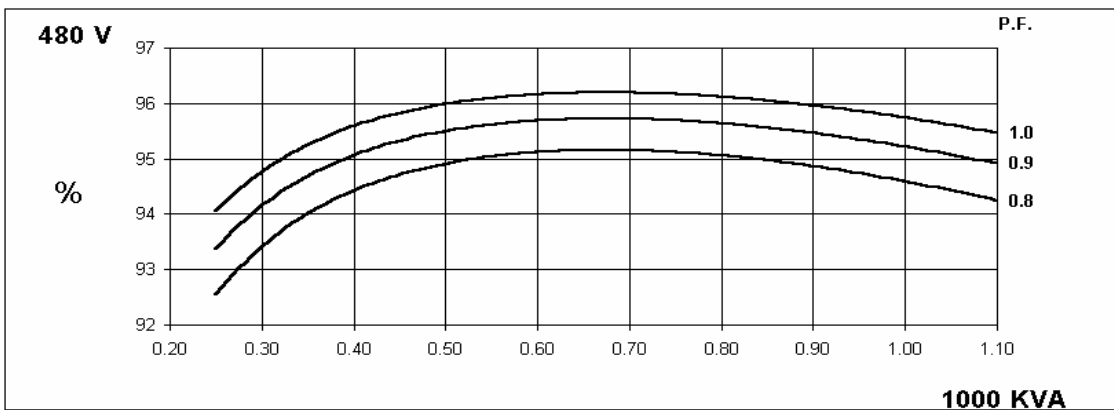
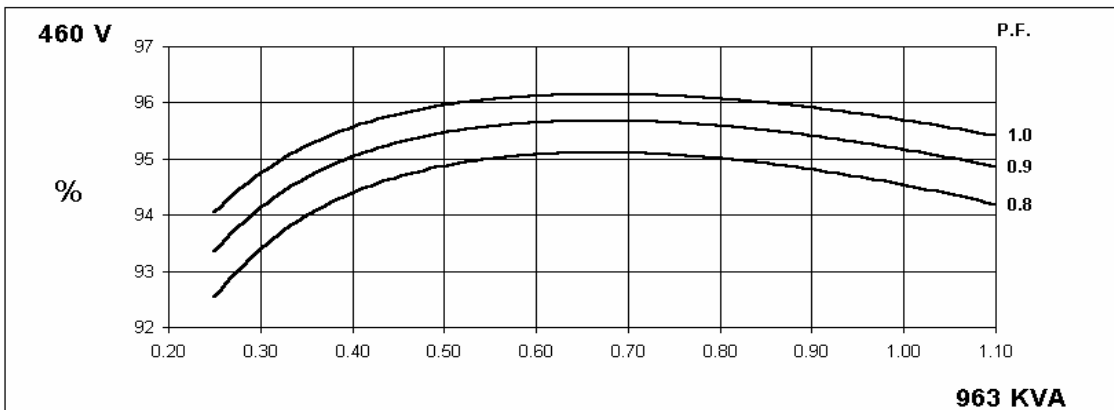
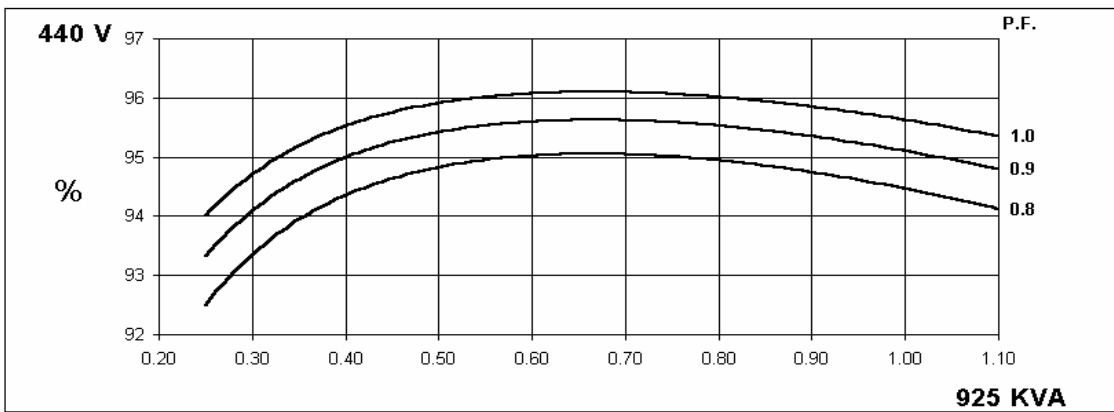
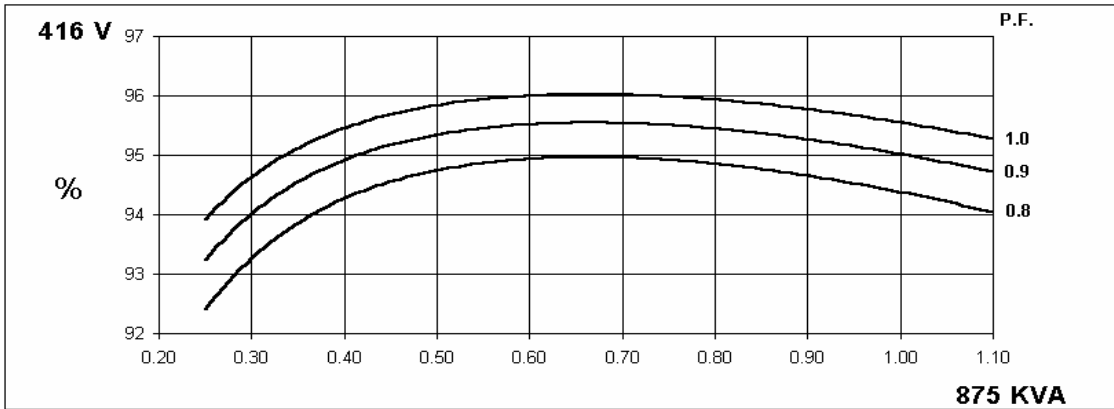

HCI634G

Winding 312



Locked Rotor Motor Starting Curve

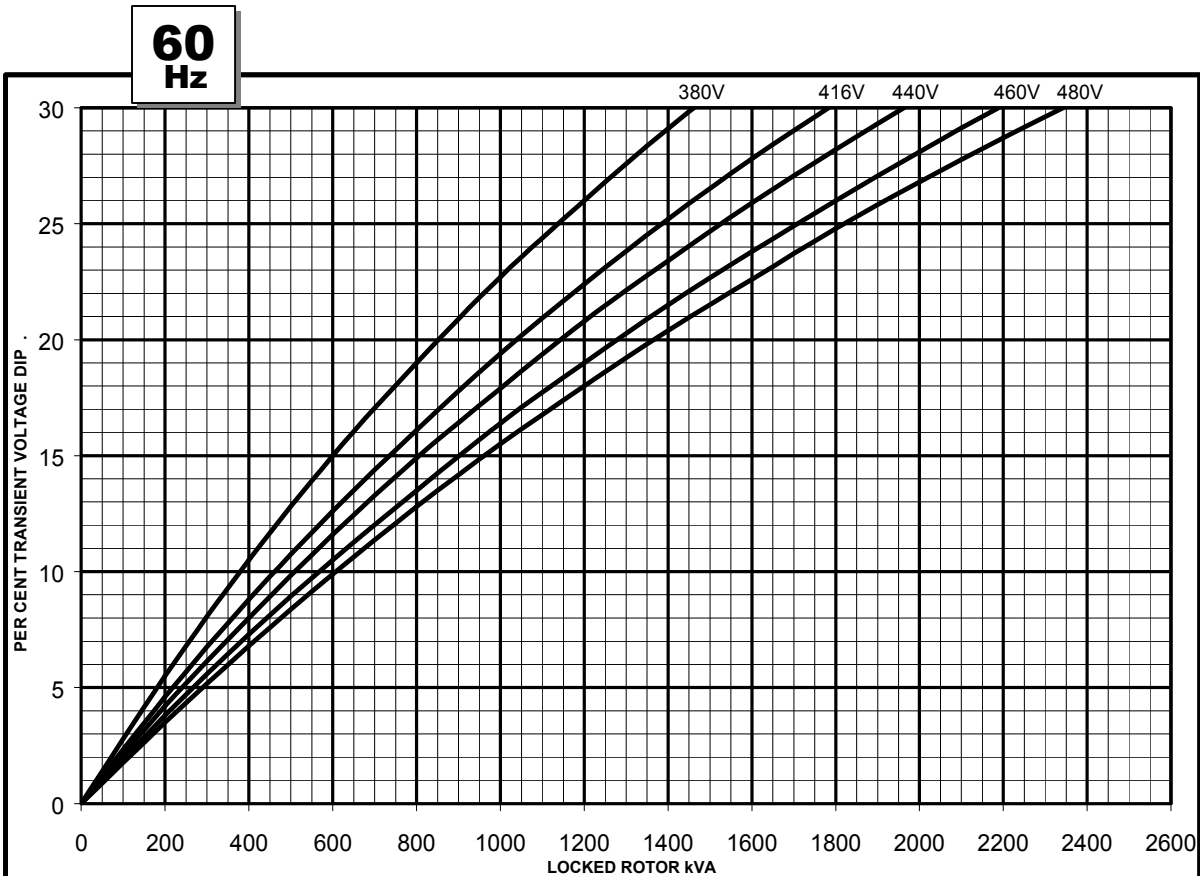
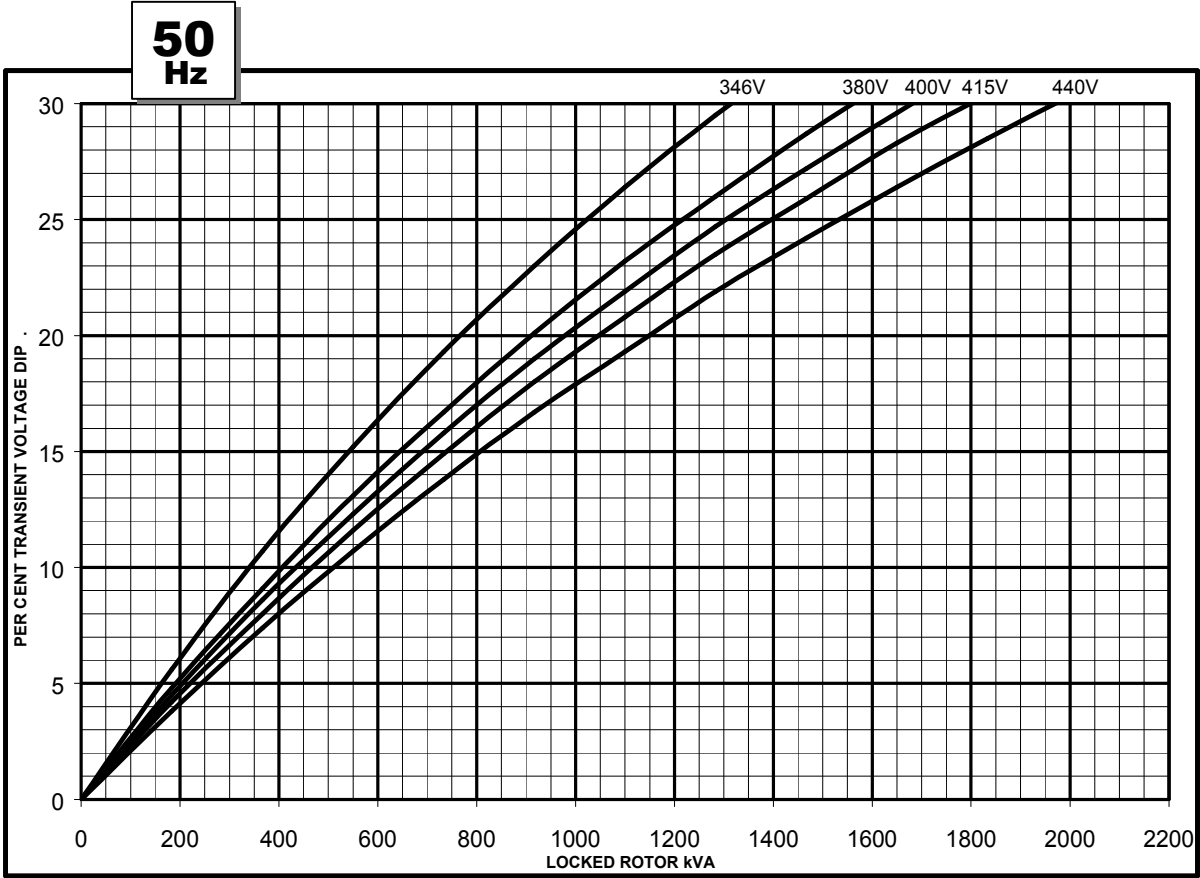

**Three-phase Short Circuit Decrement Curve. No-load Excitation at Rated Speed
Based on star (wye) connection.**

**50
Hz**

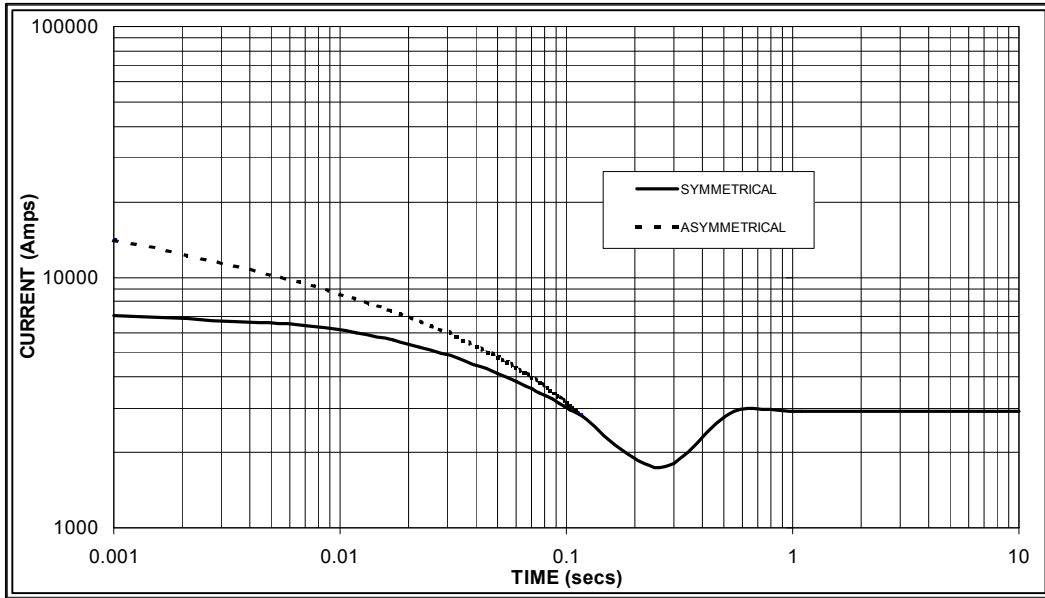

Sustained Short Circuit = 2,900 Amps

**60
Hz**

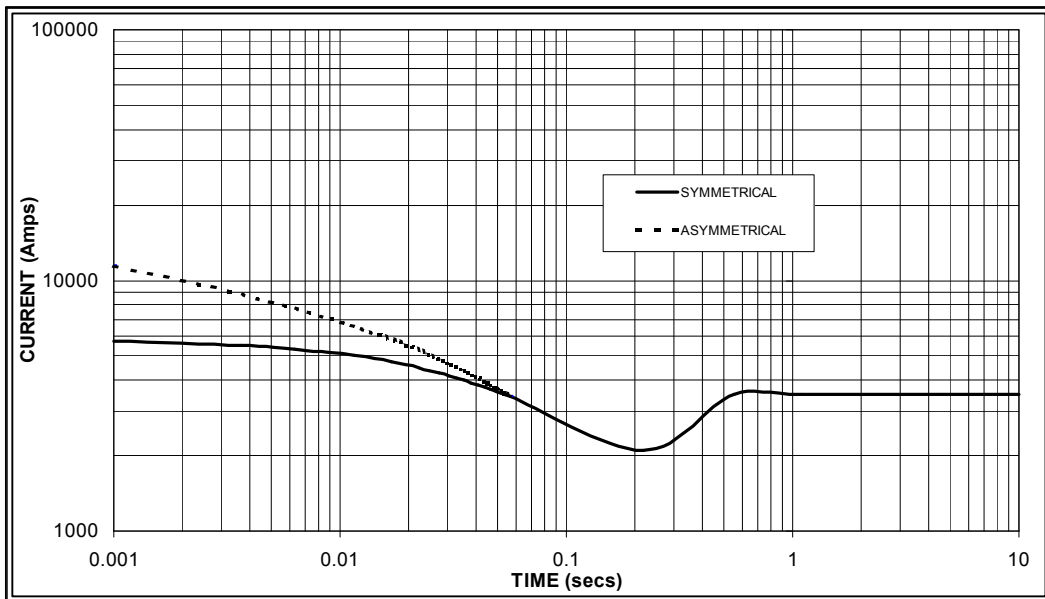

Sustained Short Circuit = 3,500 Amps

Note 1

The following multiplication factors should be used to adjust the values from curve between time 0.001 seconds and the minimum current point in respect of nominal operating voltage :

50Hz		60Hz	
Voltage	Factor	Voltage	Factor
380v	X 1.00	416v	x 1.00
400v	X 1.07	440v	x 1.06
415v	X 1.12	460v	x 1.12
440v	X 1.18	480v	x 1.17

The sustained current value is constant irrespective of voltage level

Note 2

The following multiplication factor should be used to convert the values calculated in accordance with NOTE 1 to those applicable to the various types of short circuit :

	3-phase	2-phase L-L	1-phase L-N
Instantaneous	x 1.00	x 0.87	x 1.30
Minimum	x 1.00	x 1.80	x 3.20
Sustained	x 1.00	x 1.50	x 2.50
Max. sustained duration	10 sec.	5 sec.	2 sec.

All other times are unchanged

Note 3

Curves are drawn for Star (Wye) connected machines. For Delta connection multiply the Curve current value by 1.732

HCI634G

Winding 312 0.8 Power Factor



RATINGS

Class - Temp Rise		Cont. F - 105/40°C				Cont. H - 125/40°C				Standby - 150/40°C				Standby - 163/27°C			
50Hz	Star (V)	380	400	415	440	380	400	415	440	380	400	415	440	380	400	415	440
	Delta (V)	220	230	240	254	220	230	240	254	220	230	240	254	220	230	240	254
	kVA	750	760	750	750	800	810	800	800	820	830	820	820	850	860	850	850
	kW	600	608	600	600	640	648	640	640	656	664	656	656	680	688	680	680
	Efficiency (%)	94.5	94.6	94.8	95.0	94.2	94.4	94.6	94.8	94.1	94.3	94.5	94.7	93.9	94.2	94.4	94.6
	kW Input	635	643	633	632	679	686	677	675	697	704	694	693	724	730	720	719
60Hz	Star (V)	416	440	460	480	416	440	460	480	416	440	460	480	416	440	460	480
	Delta (V)	240	254	266	277	240	254	266	277	240	254	266	277	240	254	266	277
	kVA	813	844	888	913	875	925	963	1000	913	969	1008	1046	950	1000	1044	1088
	kW	650	675	710	730	700	740	770	800	730	775	806	837	760	800	835	870
	Efficiency (%)	94.6	94.7	94.8	94.8	94.4	94.5	94.5	94.6	94.2	94.3	94.4	94.4	94.1	94.2	94.3	94.3
	kW Input	688	713	749	770	742	783	815	846	775	822	854	886	808	849	886	923

DIMENSIONS

