

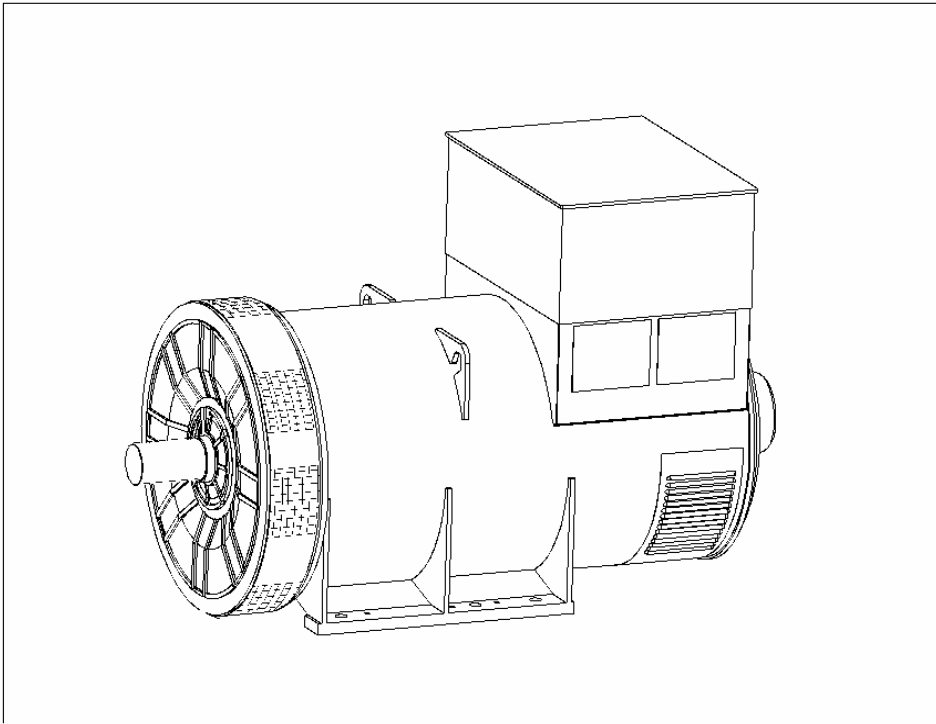

# STAMFORD®

## PI734B - Technical Data Sheet



# PI734B

## SPECIFICATIONS & OPTIONS



### STANDARDS

Newage Stamford industrial generators meet the requirements of BS EN 60034 and the relevant sections of other national and international standards such as BS5000, VDE 0530, NEMA MG1-32, IEC60034, CSA C22.2-100, AS1359.

Other standards and certifications can be considered on request.

### DESCRIPTION

The STAMFORD PI range of synchronous ac generators are brushless with a rotating field. They are separately excited by the STAMFORD Permanent Magnet Generator (PMG). This is a shaft mounted, high frequency, pilot exciter which provides a constant supply of clean power via the Automatic Voltage Regulator (AVR) to the main exciter. The main exciter output is fed to the main rotor, through a full wave bridge rectifier, protected by surge suppression.

### VOLTAGE REGULATORS

The PI range generators, complete with a PMG, are available with one of two AVRs. Each AVR has soft start voltage build up and built in protection against sustained over-excitation, which will de-excite the generator after a minimum of 8 seconds.

Underspeed protection (UFRO) is also provided on both AVRs. The UFRO will reduce the generator output voltage proportional to the speed of the generator below a pre-settable level.

The **MX341 AVR** is two phase sensed with a voltage regulation of  $\pm 1\%$ . (see the note on regulation).

The **MX321 AVR** is 3 phase rms sensed with a voltage regulation of 0.5% rms (see the note on regulation). The UFRO circuit has adjustable slope and dwell for controlled recovery from step loads. An over voltage protection circuit will shutdown the output device of the AVR, it can also trip an optional excitation circuit breaker if required. As an option, short circuit current limiting is available with the addition of current transformers.

Both the MX341 and the MX321 need a generator mounted current transformer to provide quadrature droop characteristics for load sharing during parallel operation. Provision is also made for the connection of the STAMFORD power factor controller, for embedded applications, and a remote voltage trimmer.

### WINDINGS & ELECTRICAL PERFORMANCE

All generator stators are wound to 2/3 pitch. This eliminates triplen (3rd, 9th, 15th ...) harmonics on the voltage waveform and is found to be the optimum design for trouble-free supply of non-linear loads. The 2/3 pitch design avoids excessive neutral currents sometimes seen with higher winding pitches. A fully connected damper winding reduces oscillations during paralleling. This winding, with the 2/3 pitch and carefully selected pole and tooth designs, ensures very low levels of voltage waveform distortion.

### TERMINALS & TERMINAL BOX

Standard generators feature a main stator with 6 ends brought out to the terminals, which are mounted on the frame at the non-drive end of the generator. A sheet steel terminal box contains the AVR and provides ample space for the customers' wiring and gland arrangements. It has removable panels for easy access.

### SHAFT & KEYS

All generator rotors are dynamically balanced to better than BS6861:Part 1 Grade 2.5 for minimum vibration in operation. Two bearing generators are balanced with a half key.

### INSULATION/IMPREGNATION

The insulation system is class 'H', and meets the requirements of UL1446.

All wound components are impregnated with materials and processes designed specifically to provide the high build required for static windings and the high mechanical strength required for rotating components.

### QUALITY ASSURANCE

Generators are manufactured using production procedures having a quality assurance level to BS EN ISO 9001.

### NOTE ON REGULATION

The stated voltage regulation may not be maintained in the presence of certain radio transmitted signals. Any change in performance will fall within the limits of Criteria 'B' of EN 61000-6-2:2001. At no time will the steady-state voltage regulation exceed 2%.

Note: Continuous development of our products entitles us to change specification details without notice, therefore they must not be regarded as binding.

Front cover drawing is typical of the product range.

**PI734B**  
**WINDING 312**

CONTROL SYSTEM	SEPARATELY EXCITED BY P.M.G.		
A.V.R.	MX341	MX321	
VOLTAGE REGULATION	± 1%	± 0.5 %	With 4% ENGINE GOVERNING
SUSTAINED SHORT CIRCUIT	REFER TO SHORT CIRCUIT DECREMENT CURVES (page 7)		

INSULATION SYSTEM	CLASS H
PROTECTION	IP23
RATED POWER FACTOR	0.8
STATOR WINDING	DOUBLE LAYER LAP
WINDING PITCH	TWO THIRDS
WINDING LEADS	6
MAIN STATOR RESISTANCE	0.0016 Ohms PER PHASE AT 22°C STAR CONNECTED
MAIN ROTOR RESISTANCE	1.67 Ohms at 22°C
EXCITER STATOR RESISTANCE	17.5 Ohms at 22°C
EXCITER ROTOR RESISTANCE	0.048 Ohms PER PHASE AT 22°C
R.F.I. SUPPRESSION	BS EN 61000-6-2 & BS EN 61000-6-4, VDE 0875G, VDE 0875N. refer to factory for others
WAVEFORM DISTORTION	NO LOAD < 1.5% NON-DISTORTING BALANCED LINEAR LOAD < 5.0%
MAXIMUM OVERSPEED	2250 Rev/Min
BEARING DRIVE END	BALL. 6228 C3
BEARING NON-DRIVE END	BALL. 6319 C3

	1 BEARING	2 BEARING
WEIGHT COMP. GENERATOR	2760 kg	2710 kg
WEIGHT WOUND STATOR	1306 kg	1306 kg
WEIGHT WOUND ROTOR	1139 kg	1077 kg
WR <sup>2</sup> INERTIA	32.7498 kgm <sup>2</sup>	31.7489 kgm <sup>2</sup>
SHIPPING WEIGHTS in a crate	2833kg	2779kg
PACKING CRATE SIZE	194 x 105 x 154(cm)	194 x 105 x 154(cm)

	50 Hz				60 Hz			
TELEPHONE INTERFERENCE	THF<2%				TIF<50			
COOLING AIR	2.69 m <sup>3</sup> /sec 5700 cfm				3.45 m <sup>3</sup> /sec 7300 cfm			
VOLTAGE STAR	380/220	400/231	415/240	440/254	416/240	440/254	460/266	480/277
KVA BASE RATING FOR REACTANCE VALUES	1360	1400	1400	1375	1525	1625	1655	1690
X <sub>d</sub> DIR. AXIS SYNCHRONOUS	3.50	3.26	3.02	2.64	4.25	4.04	3.77	3.53
X' <sub>d</sub> DIR. AXIS TRANSIENT	0.21	0.20	0.18	0.16	0.26	0.25	0.23	0.22
X'' <sub>d</sub> DIR. AXIS SUBTRANSIENT	0.16	0.15	0.14	0.12	0.19	0.18	0.17	0.16
X <sub>q</sub> QUAD. AXIS REACTANCE	2.26	2.10	1.95	1.70	2.74	2.61	2.43	2.28
X'' <sub>q</sub> QUAD. AXIS SUBTRANSIENT	0.32	0.29	0.27	0.24	0.38	0.37	0.34	0.32
X <sub>L</sub> LEAKAGE REACTANCE	0.04	0.04	0.03	0.03	0.05	0.05	0.04	0.04
X <sub>2</sub> NEGATIVE SEQUENCE	0.22	0.21	0.19	0.17	0.27	0.26	0.24	0.23
X <sub>0</sub> ZERO SEQUENCE	0.03	0.03	0.02	0.02	0.03	0.03	0.03	0.03

REACTANCES ARE SATURATED

VALUES ARE PER UNIT AT RATING AND VOLTAGE INDICATED

T' <sub>d</sub> TRANSIENT TIME CONST.	0.13s
T'' <sub>d</sub> SUB-TRANSTIME CONST.	0.01s
T' <sub>do</sub> O.C. FIELD TIME CONST.	2.14s
T <sub>a</sub> ARMATURE TIME CONST.	0.02s
SHORT CIRCUIT RATIO	1/X <sub>d</sub>

**50  
Hz**

**PI734B**  
Winding 312



**THREE PHASE EFFICIENCY CURVES**

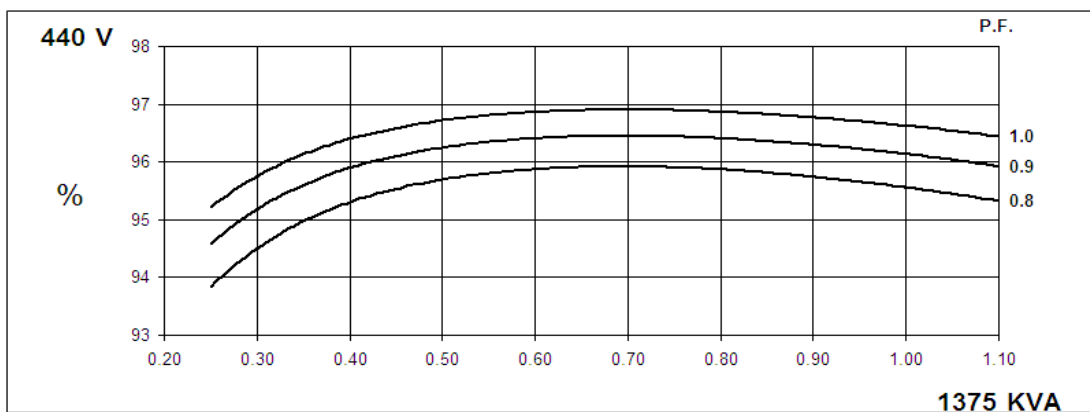
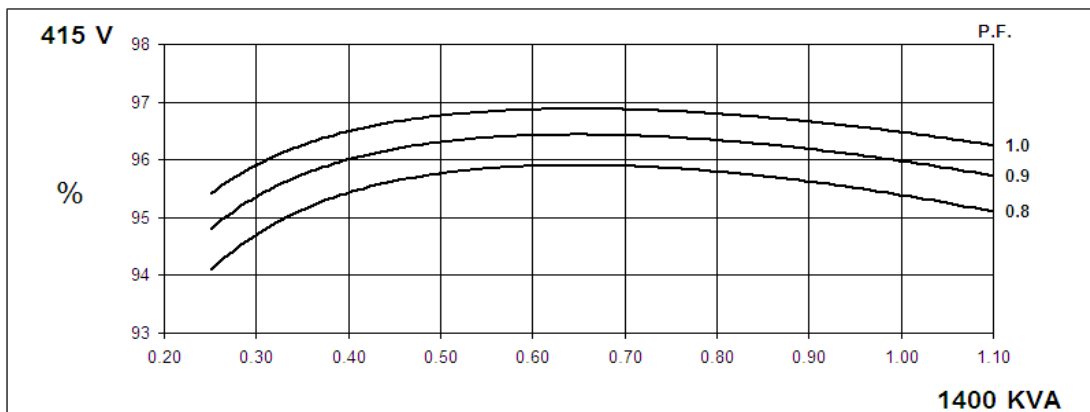
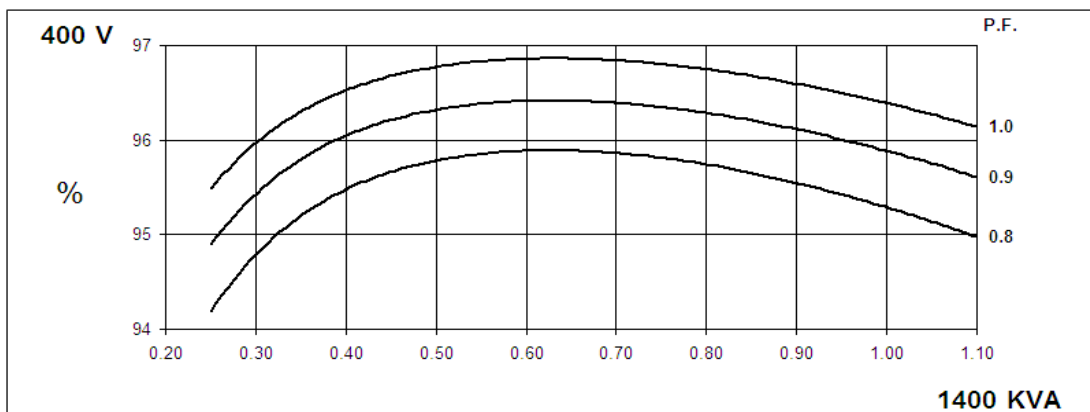
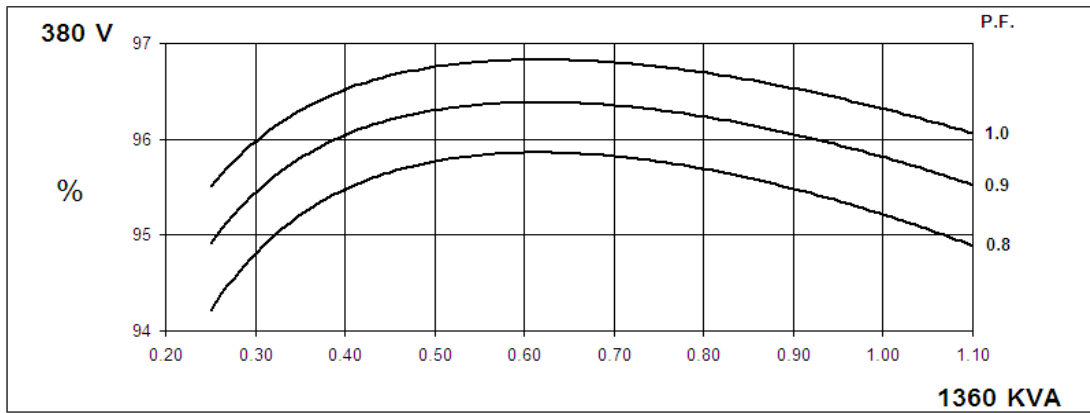

**THREE PHASE EFFICIENCY CURVES**

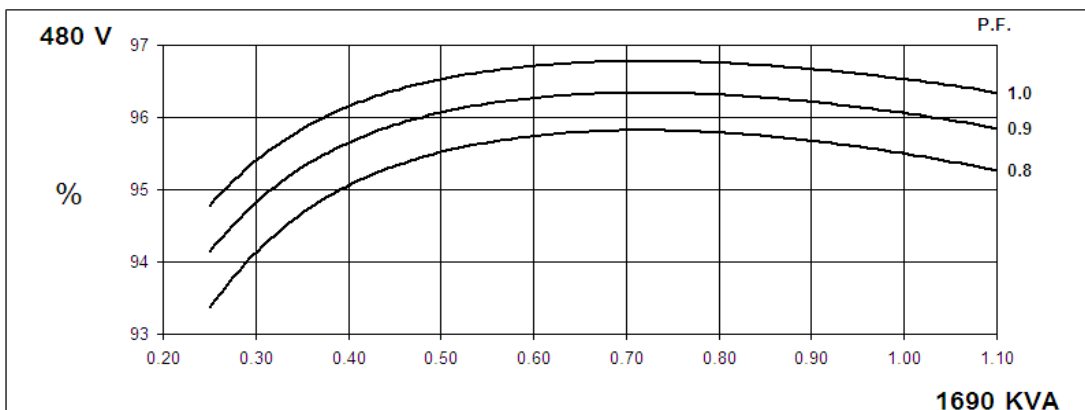
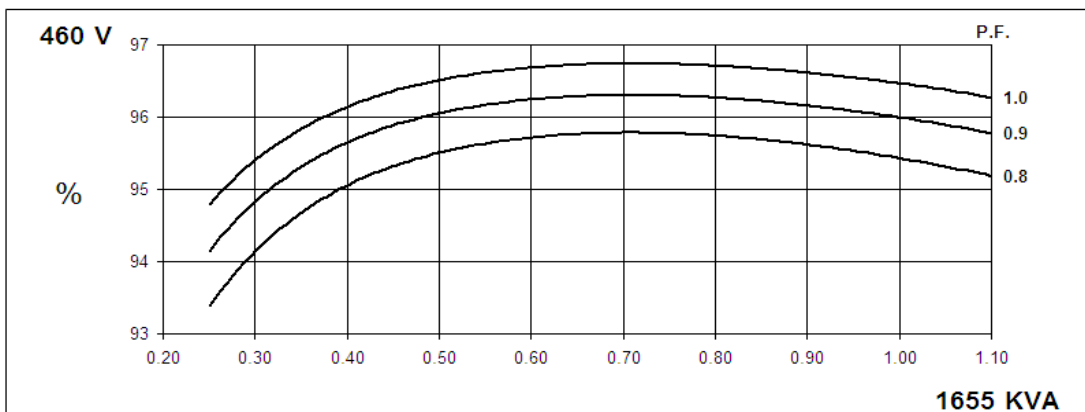
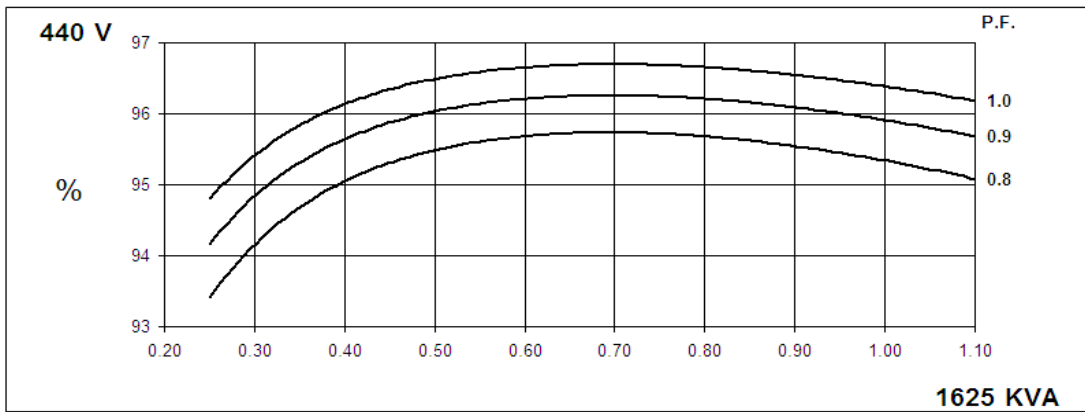
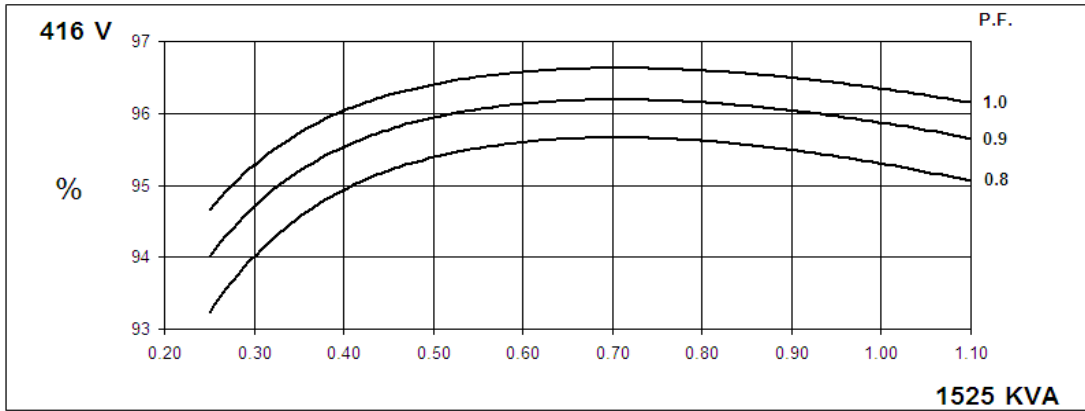

# PI734B

## Winding 312



### Locked Rotor Motor Starting Curve

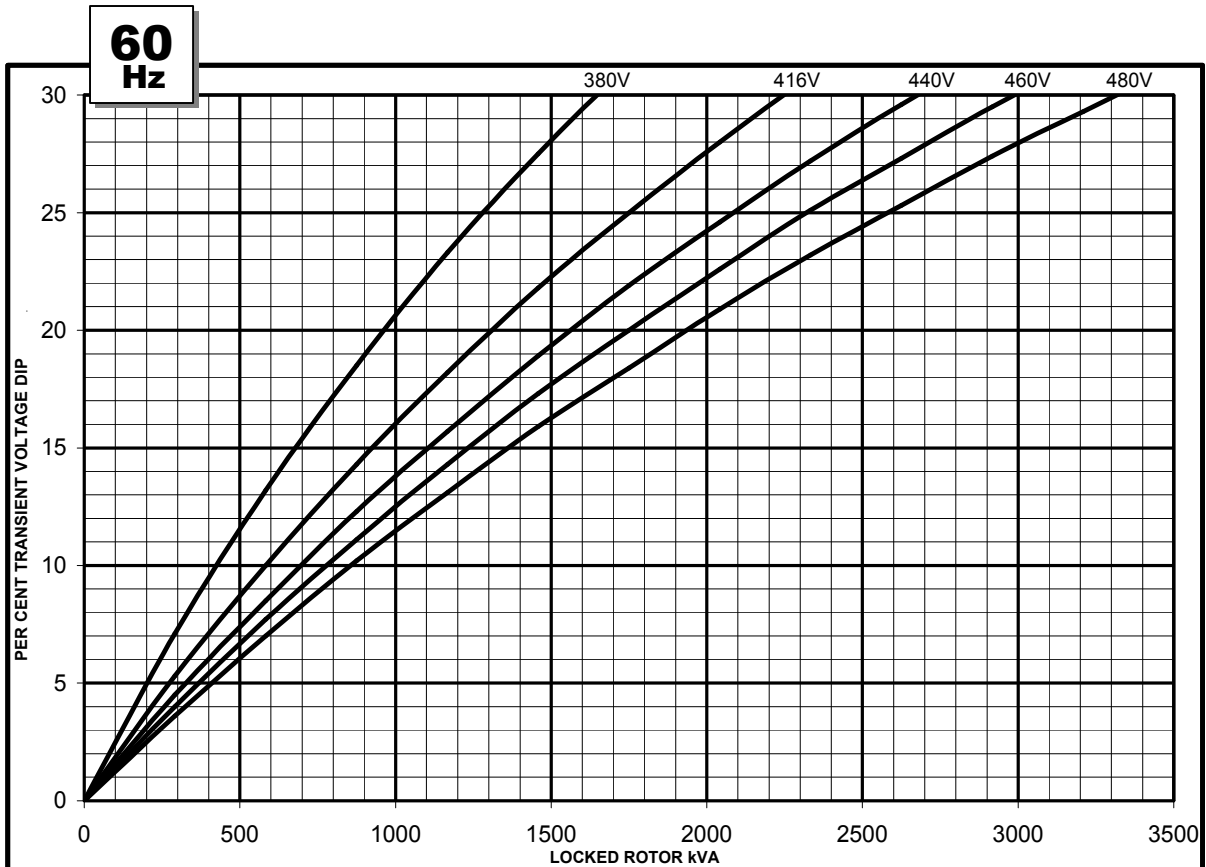
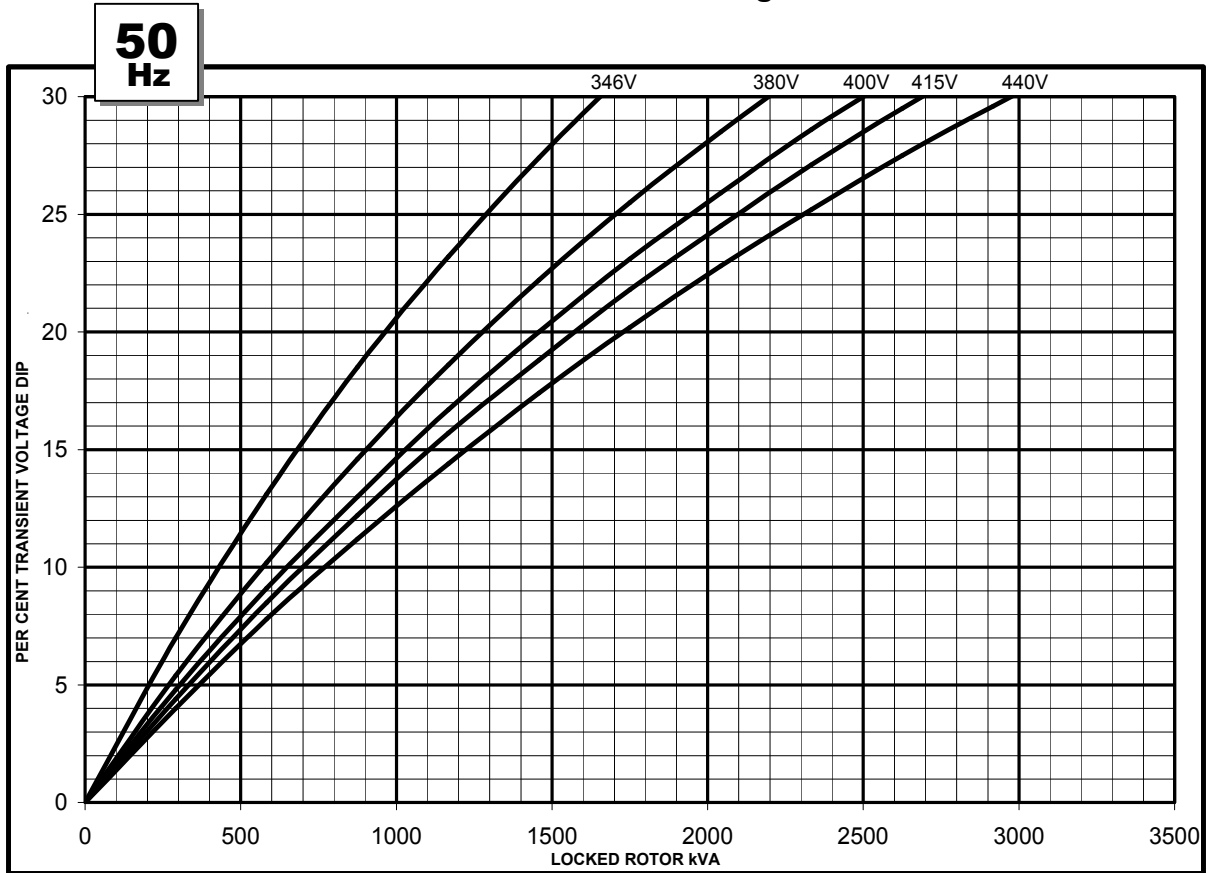

**Three-phase Short Circuit Decrement Curve. No-load Excitation at Rated Speed  
Based on star (wye) connection.**

**50  
Hz**

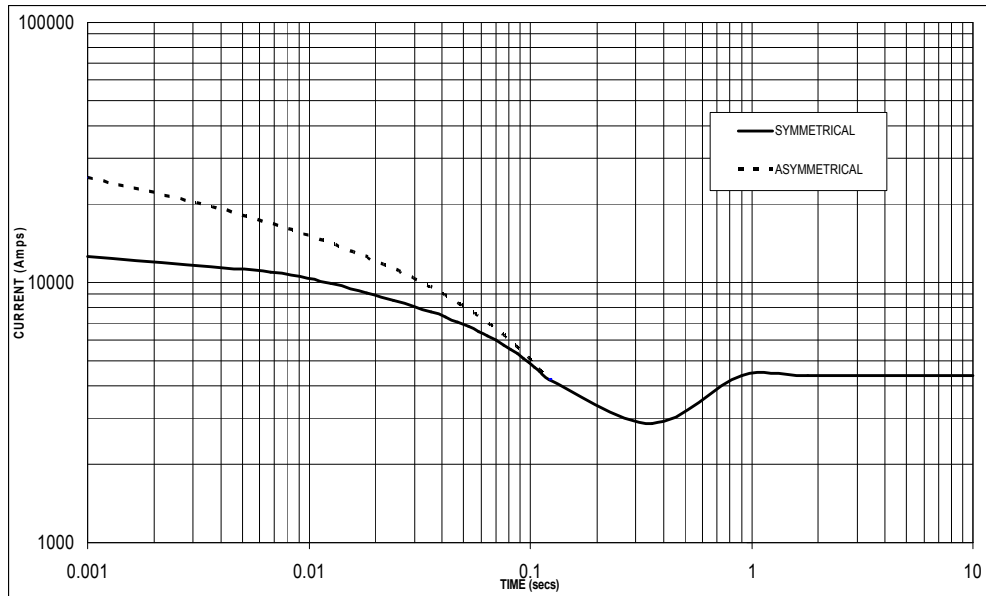

Sustained Short Circuit = 4,400 Amps

**60  
Hz**

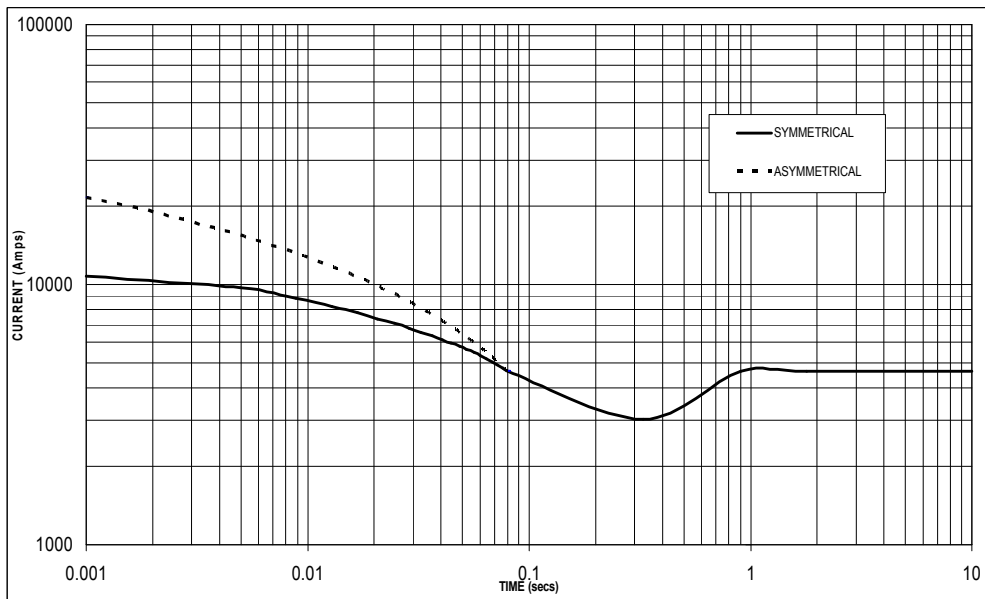

Sustained Short Circuit = 4,650 Amps

**Note 1**

The following multiplication factors should be used to adjust the values from curve between time 0.001 seconds and the minimum current point in respect of nominal operating voltage :

50Hz		60Hz	
Voltage	Factor	Voltage	Factor
380v	x 1.00	416v	x 1.00
400v	x 1.05	440v	x 1.06
415v	x 1.09	460v	x 1.10
440v	x 1.16	480v	x 1.15

The sustained current value is constant irrespective of voltage level

**Note 2**

The following multiplication factor should be used to convert the values calculated in accordance with NOTE 1 to those applicable to the various types of short circuit :

	3-phase	2-phase L-L	1-phase L-N
Instantaneous	x 1.00	x 0.87	x 1.30
Minimum	x 1.00	x 1.80	x 3.20
Sustained	x 1.00	x 1.50	x 2.50
Max. sustained duration	10 sec.	5 sec.	2 sec.

All other times are unchanged

**Note 3**

Curves are drawn for Star (Wye) connected machines.

# PI734B

## Winding 312 / 0.8 Power Factor



### RATINGS

Class - Temp Rise	Cont. F - 105/40°C				Cont. H - 125/40°C				Standby - 150/40°C				Standby - 163/27°C			
<b>50Hz</b> Star (V)	380	400	415	440	380	400	415	440	380	400	415	440	380	400	415	440
kVA	1265	1305	1305	1280	1360	1400	1400	1375	1415	1460	1460	1430	1455	1500	1500	1470
kW	1012	1044	1044	1024	1088	1120	1120	1100	1132	1168	1168	1144	1164	1200	1200	1176
Efficiency (%)	95.4	95.5	95.6	95.7	95.2	95.3	95.4	95.6	95.1	95.2	95.3	95.5	95.0	95.1	95.2	95.4
kW Input	1061	1093	1092	1070	1143	1175	1174	1151	1190	1227	1226	1198	1225	1262	1261	1233

<b>60Hz</b> Star (V)	416	440	460	480	416	440	460	480	416	440	460	480	416	440	460	480
kVA	1415	1510	1540	1575	1525	1625	1655	1690	1590	1690	1725	1760	1630	1740	1775	1810
kW	1132	1208	1232	1260	1220	1300	1324	1352	1272	1352	1380	1408	1304	1392	1420	1448
Efficiency (%)	95.4	95.5	95.6	95.6	95.3	95.3	95.4	95.5	95.2	95.2	95.3	95.4	95.1	95.2	95.3	95.3
kW Input	1187	1265	1289	1318	1280	1364	1388	1416	1336	1420	1448	1476	1371	1462	1490	1519

### DIMENSIONS

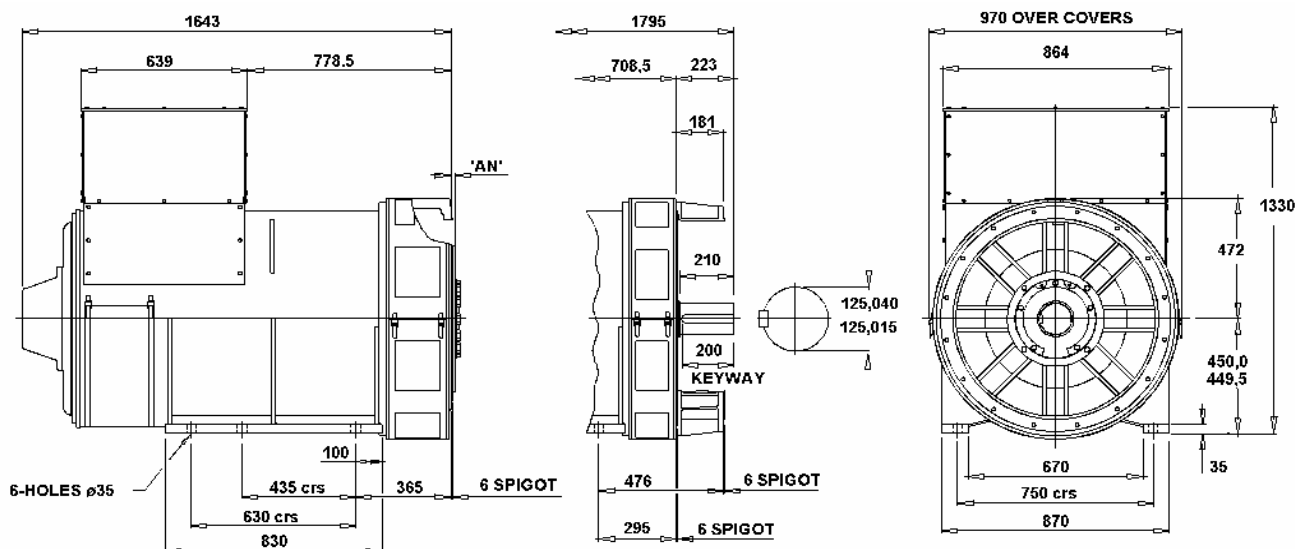

COUPLING DISC	'AN'
S.A.E No 18	15,7
S.A.E No 21	0
S.A.E No 24	0

1-BRG ADAPTORS
S.A.E No 0
S.A.E No 00

2-BRG ADAPTORS
S.A.E No 0
S.A.E No 00